

Peak Emission Wavelength: 1300nm

The LSF1302C1 consists of a 1300nm high output infrared die in a water-clear 3mm plastic molded package. Custom package solutions and sorting are available.

FEATURES

- > High Output Power
- > High Reliability
- > Compact

APPLICATIONS

- > Optical Switches
- > Optical Sensors
- > Fiber Optical Communication



Absolute Maximum Ratings (Ta=25°C)



ITEMS	SYMBOL	RATINGS	UNIT
Forward Current	IF	100	mA
Reverse Voltage	VR	5	V
Operating Temperature Range	Topr	-40 ~ +85	°C

*1: Tw=10μsec, T=10msec; *2: Time 5 Sec max, Position: Up to 3mm from the body.

Electrical & Optical Characteristics (Ta = 25°C)

ITEMS	SYMBOL	CONDITIONS	MIN	TYP	MAX	UNIT
Power Output	PO	IF=50mA	--	17.4	--	mW
Forward Voltage	VF	IF=50mA	--	1.10	--	V
Reverse Current	IR	VR=5V	--	--	100	μA
Peak Emission Wavelength	λp	IF=50mA	--	1300	--	nm
Spectral Line Half Width	Δλ	IF=50mA	--	79	--	nm
Half Intensity Beam Angle	Θ	IF=50mA	--	±48	--	deg

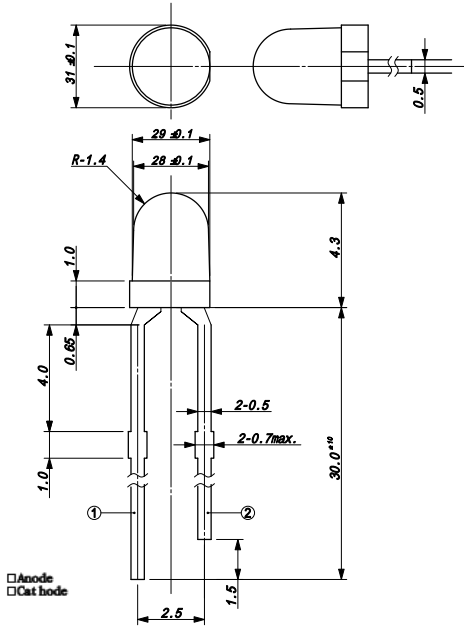

SPECTRAL RESPONSE

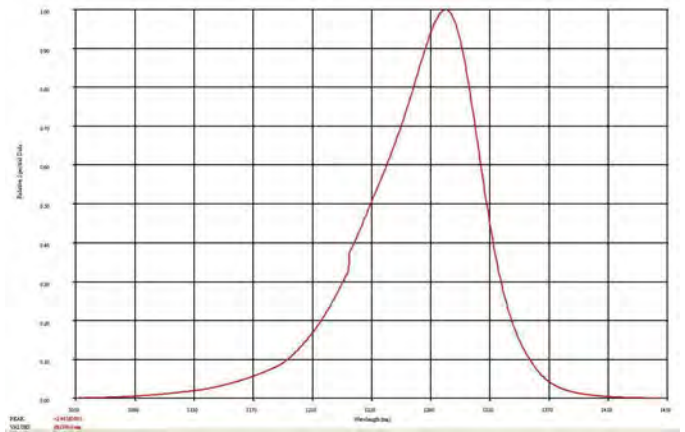

RADIATION DISTRIBUTION

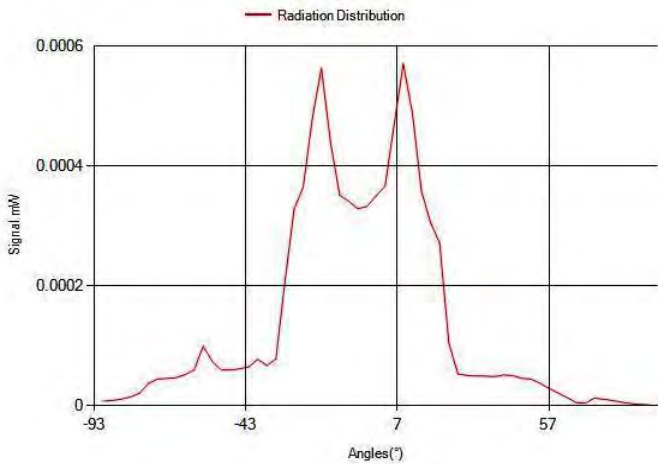

VIEW ANGLE

