

Peak Sensitivity Wavelength: 650nm

The 650nm Point Source Series is designed for applications requiring high output and precise optical / mechanical axis alignment. It is packaged in a 1.6mm square SMD black package with clear encapsulation.

FEATURES

- > 1.6mm square SMD package
- > Wide Beam Angle
- > Emitting Window Diameter Φ 170 μ m

APPLICATIONS

- > Optical Switches / Security Systems
- > Linear & Rotary Encoder
- > Remote Controls / Robotics

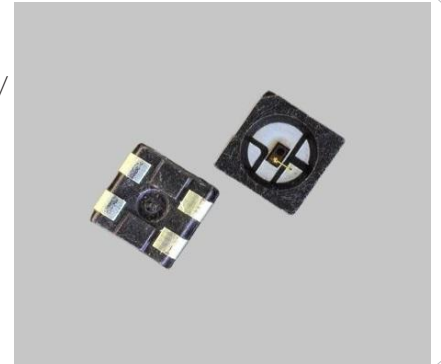

Absolute Maximum Ratings (Ta=25°C)



ITEMS	SYMBOL	RATINGS	UNIT
Forward Current	IF	80	mA
Reverse Voltage	VR	3	V
Operating Temperature Range	Topr	-40 ~ +85	°C
Storage Temperature Range	Tstg	-40 ~ +100	°C

Electrical & Optical Characteristics (Ta = 25°C)

ITEMS	SYMBOL	CONDITIONS	MIN	TYP	MAX	UNIT
Power Output	PO	IF=20mA	--	3.82	--	mW
Forward Voltage	VF	IF=20mA	--	1.94	--	V
Reverse Current	IR	VR=5V	--	--	100	μ A
Peak Emission Wavelength	λ_p	IF=20mA	--	650	--	nm
Spectral Line Half Width	$\Delta\lambda$	IF=20mA	--	19	--	nm
Half Intensity Beam Angle	Θ	IF=20mA	--	+/-118	--	deg

Note: Care is required during assembly and when handling the component so as to not damage the surface of the LED.
This may affect the appearance and optical performance.

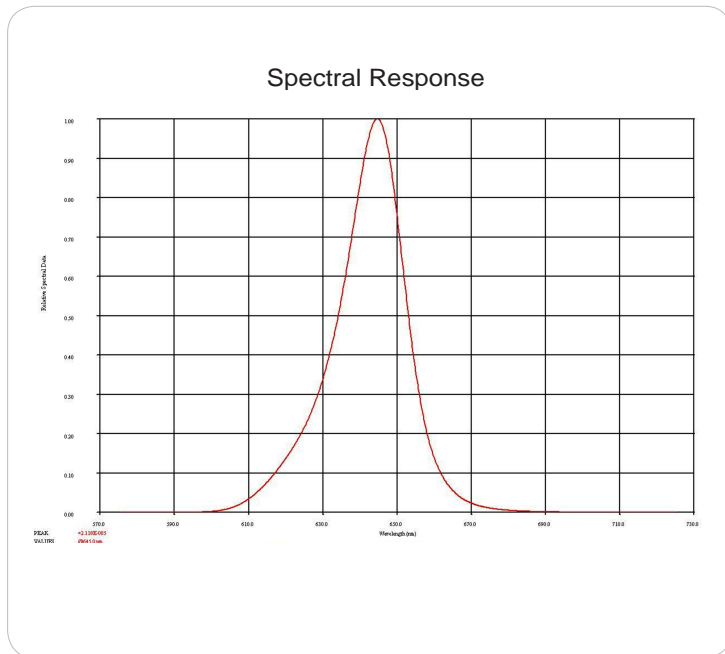
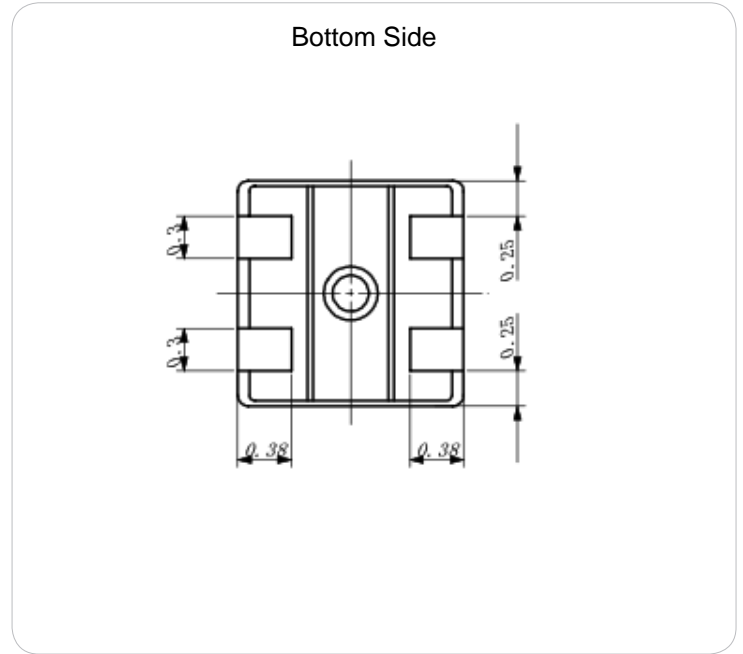
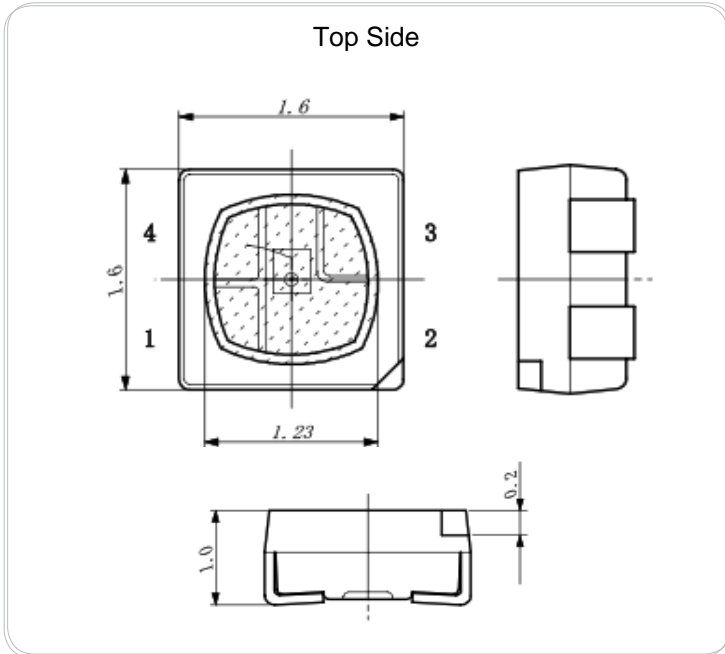

Unit: mm, Tolerance: ± 0.2

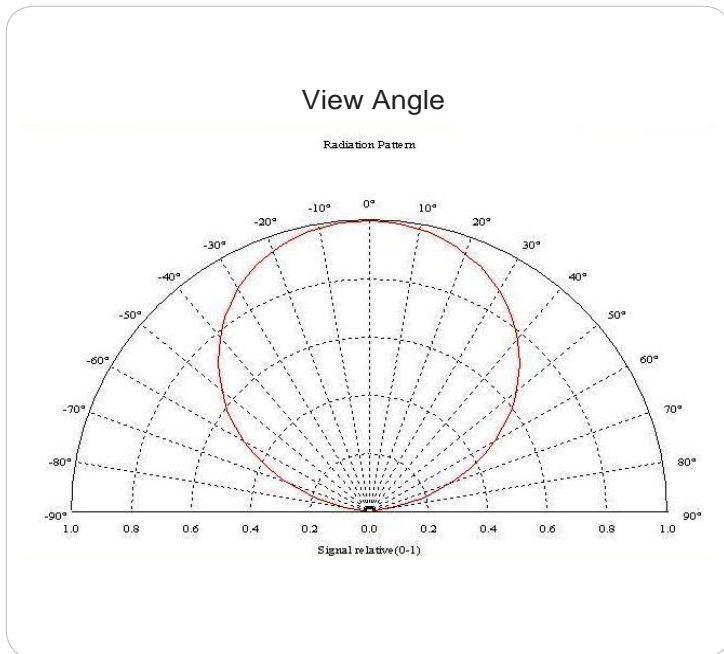
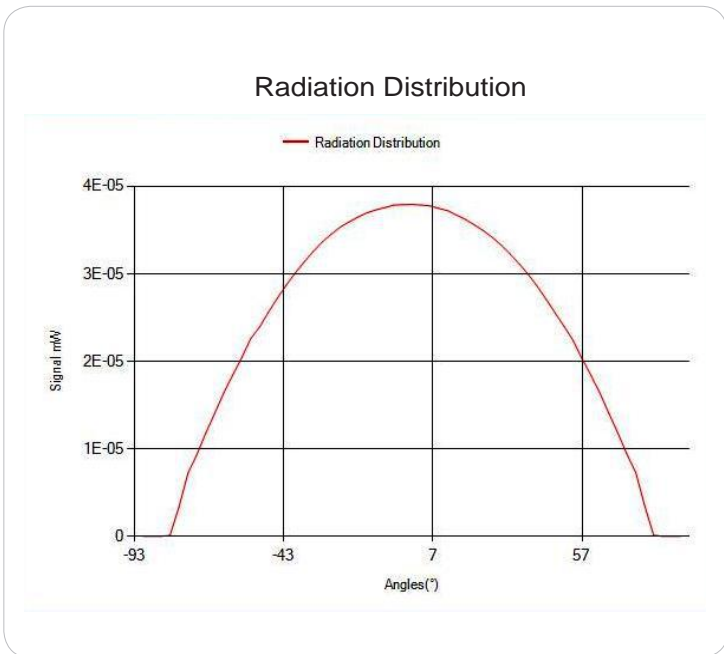
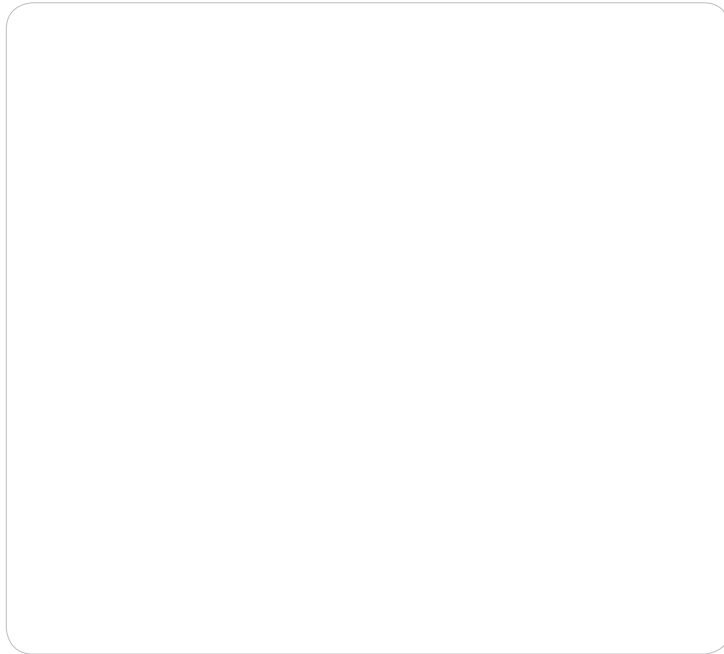
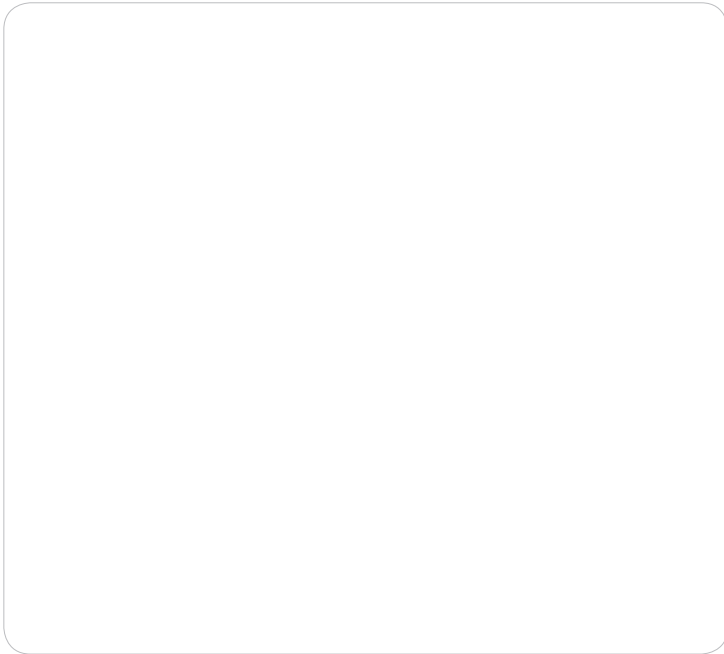

The information contained herein is subject to change without notice.

2026-03-27