

Peak Emission Wavelength: 850nm

The MTE8600C consists of a 850nm high output infrared die in a water-clear 3mm plastic molded package. Custom package solutions and sorting are available.

FEATURES

- > High Output Power
- > Compact
- > High Reliability

APPLICATIONS

- > Optical Switches & Sensors
- > Fiber Optical Communication

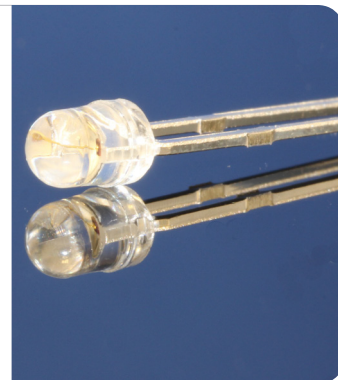

Absolute Maximum Ratings (Ta=25°C)



| ITEMS | SYMBOL | RATINGS | UNIT |
|------------------------------|--------|------------|------|
| Forward Current (DC) | IF | 100 | mA |
| Forward Current (Pulse)*1 | IFP | 1 | A |
| Reverse Voltage | VR | 5 | V |
| Power Dissipation | PD | 190 | mW |
| Operating Temperature Range | Topr | -20 ~ +80 | °C |
| Storage Temperature Range | Tstg | -30 ~ +100 | °C |
| Junction Temperature | Tj | 100 | °C |
| Lead Soldering Temperature*2 | Tls | 260 | °C |

*1: Tw=10μsec, T=10msec. *2: Time 5Sec max, Position: Up to 3mm from the body.

Electrical & Optical Characteristics (Ta = 25°C)

| ITEMS | SYMBOL | CONDITIONS | MIN | TYP | MAX | UNIT |
|---------------------------|--------|------------|-----|----------|-----|------|
| Power Output | PO | IF=50mA | -- | 28.0 | -- | mW |
| Forward Voltage | VF | IF=50mA | -- | 1.45 | 1.9 | V |
| Reverse Current | IR | VR=5V | -- | -- | 100 | μA |
| Peak Emission Wavelength | λp | IF=50mA | -- | 850 | -- | nm |
| Spectral Line Half Width | Δλ | IF=50mA | -- | 30 | -- | nm |
| Half Intensity Beam Angle | Θ | IF=50mA | -- | ±25 | -- | deg |
| Switching Times | Tr, Tf | IF=50mA | -- | 150, 100 | -- | ns |

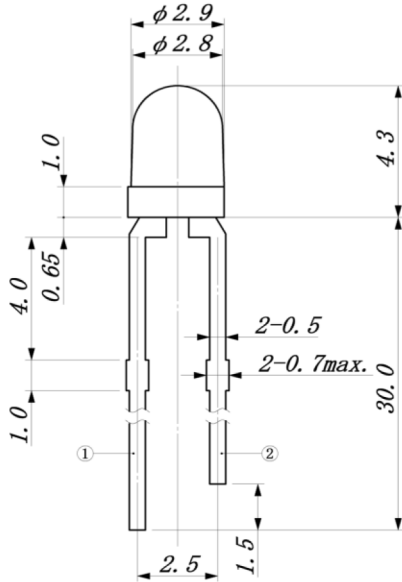

- ① Anode
- ② Cathode

SPECTRAL OUTPUT

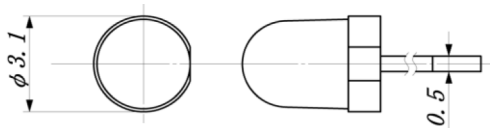
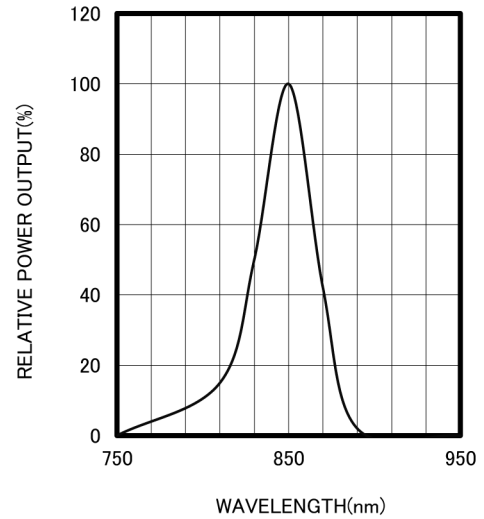

FORWARD I-V CHARACTERISTICS

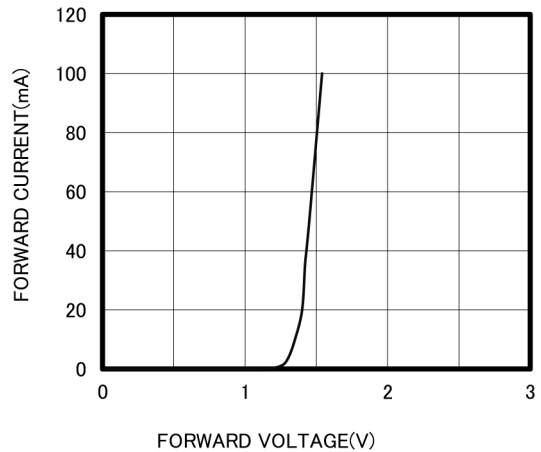

Unit: mm, Tolerance: ± 0.2

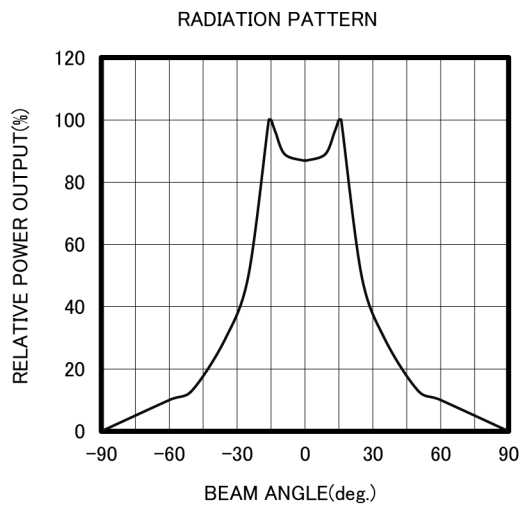
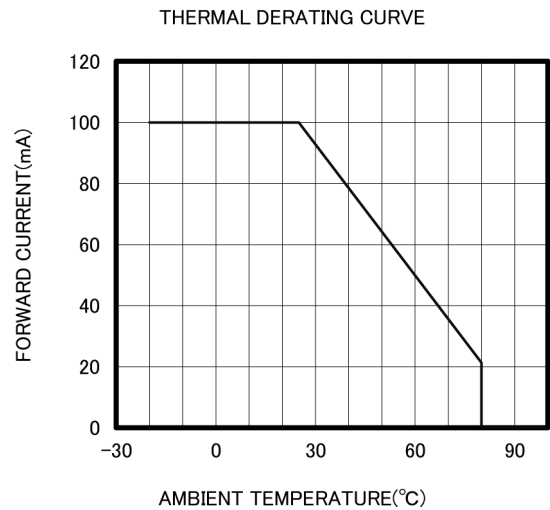
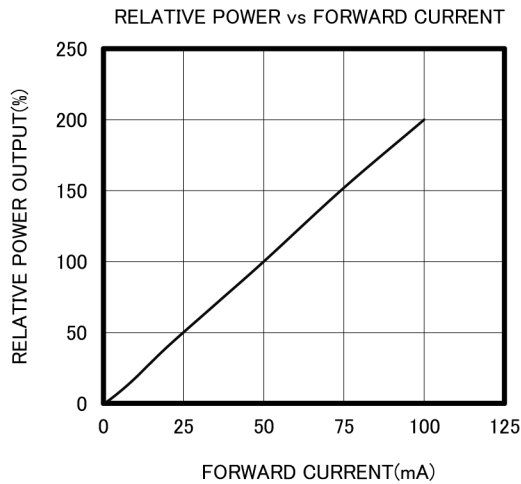

The information contained herein is subject to change without notice.

2019-11-19