

Peak Emission Wavelength: 650nm

The 650nm Point Source Series is designed for applications requiring high accuracy and precision. Custom package solutions and sorting are available.

FEATURES

- > Hermetically Sealed Pigtail Package
- > Emitting Window Diameter Φ 25 μ m
- > Gold Plated Dome Lens
- > High Reliability / High Output Power

- > Extremely Narrow Radiation Pattern

APPLICATIONS

- > Optical Sensing / Optical Instruments
- > Linear & Rotary Encoder
- > Machine Vision / CCD

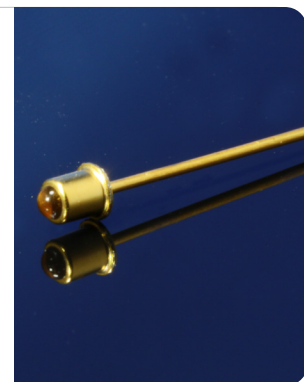

Absolute Maximum Ratings (Ta=25°C)



ITEMS	SYMBOL	RATINGS	UNIT
Forward Current (DC)	IF	15	mA
Forward Current (Pulse)*1	IFP	20	mA
Reverse Voltage	VR	5	V
Power Dissipation	PD	45	mW
Operating Temperature Range	Topr	-20 ~ +85	°C
Storage Temperature Range	Tstg	-30 ~ +100	°C
Lead Soldering Temperature*2	Tls	260	°C

*1: Tw=10 μ sec, T=10msec; *2: Time 5 Sec max, Position: Up to 3mm from the body.

Electrical & Optical Characteristics (Ta = 25°C)

ITEMS	SYMBOL	CONDITIONS	MIN	TYP	MAX	UNIT
Power Output	PO	IF=5mA	--	120	--	μ W
Forward Voltage	VF	IF=5mA	--	2.1	2.5	V
Reverse Current	IR	VR=5V	--	--	100	μ A
Peak Emission Wavelength	λ_p	IF=5mA	--	650	--	nm
Spectral Line Half Width	$\Delta\lambda$	IF=5mA	--	18	--	nm
Half Intensity Beam Angle	Θ	IF=5mA	--	± 5	--	deg

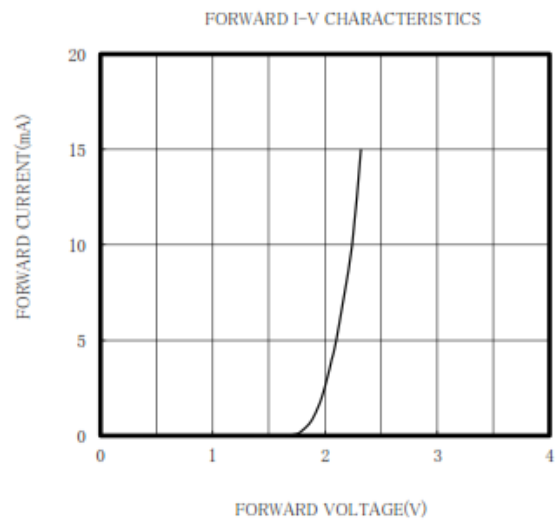
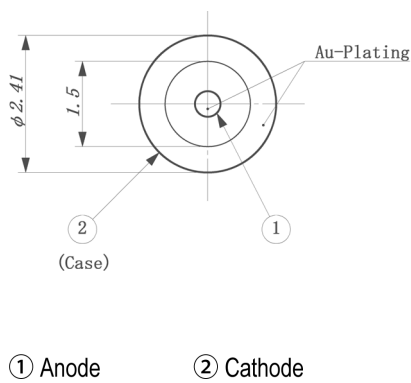
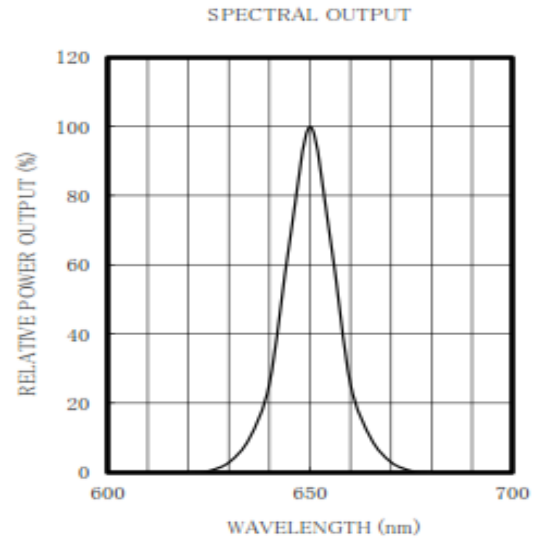
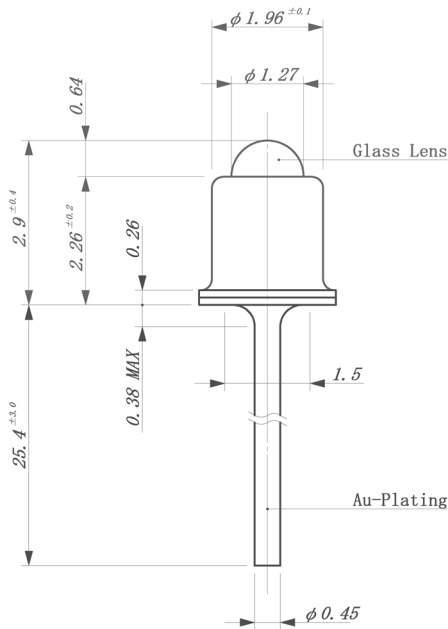

Unit: mm, Tolerance: ± 0.2

RELATIVE POWER vs FORWARD CURRENT

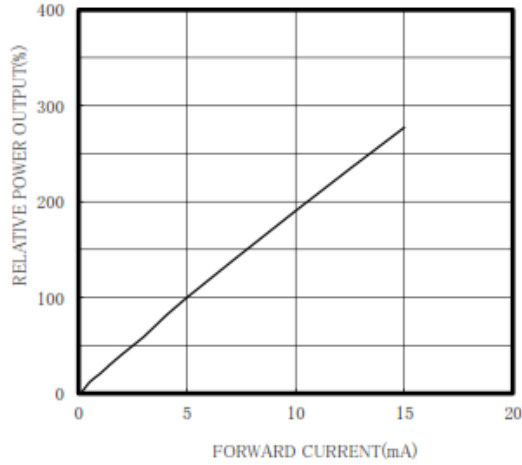

RADIATION PATTERN

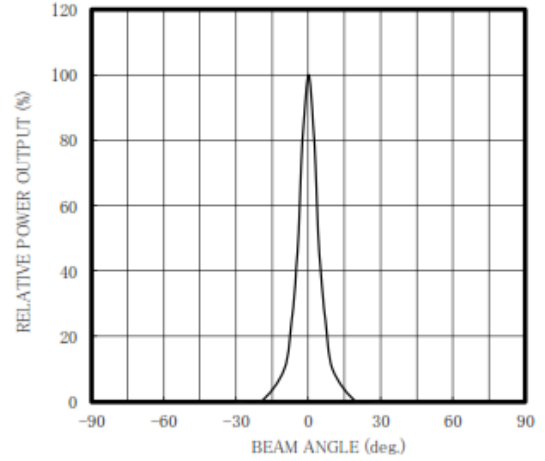

THERMAL DERATING CURVE

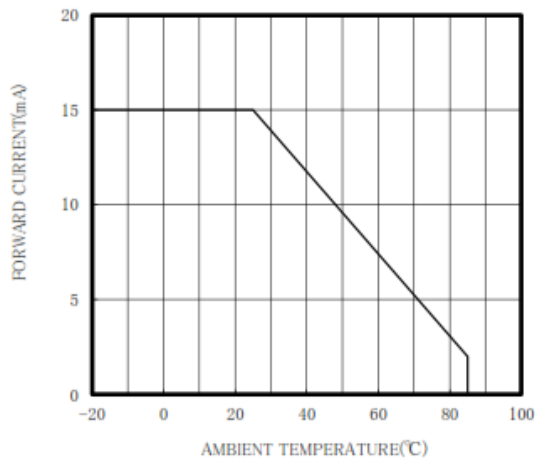

The information contained herein is subject to change without notice.

2022-08-31