

Peak Emission Wavelength: 650nm

This 650nm RCLED is designed for applications requiring high accuracy and precision. It has a 150um aperture and is packaged in a 2.1mm square SMD black package with black encapsulation.

FEATURES

- > 2.1mm square SMD Package
- > Emitting Window Diameter 150um
- > High Reliability

APPLICATIONS

- > Rangefinder
- > Red Dot Scopes
- > Optical Encoder



Absolute Maximum Ratings (Ta=25°C)



ITEMS	SYMBOL	RATINGS	UNIT
Forward Current (DC)	IF	5	mA
Reverse Voltage (@10uA)	VR	5	V
Operating Temperature Range	Topr	-20 ~ +70	°C
Storage Temperature Range	Tstg	-40 ~ +100	°C

Electrical & Optical Characteristics (Ta = 25°C)

ITEMS	SYMBOL	CONDITIONS	MIN	TYP	MAX	UNIT
Power Output	PO	IF=5mA	--	0.60	--	mW
Forward Voltage	VF	IF=5mA	--	2.1	--	V
Reverse Current	IR	VR=5V	--	--	10	µA
Peak Wavelength	λ_p	IF=5mA	640	650	660	nm
Dominant Wavelength	λ_d	IF=5mA	635	645	655	nm
Spectral Line Half Width	$\Delta\lambda$	IF=5mA	--	25	--	nm
Viewing Angle	Θ	IF=5mA	--	110	--	deg
Breakdown Voltage	Vb		--	-10	--	V

Note: Care is required during assembly and when handling the component so as to not damage the surface of the LED. This may affect the appearance and optical performance.

Top Side

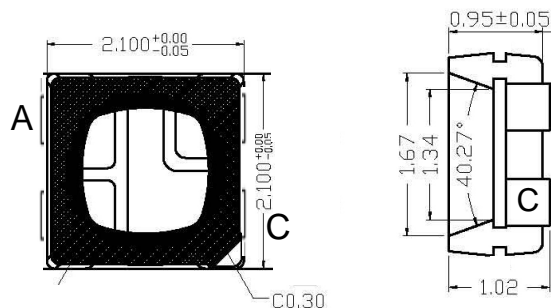

C - Cathode A - Anode

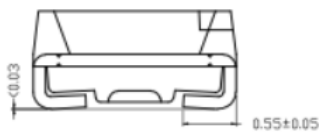

Bottom Side

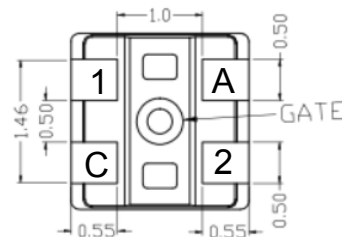

C - Cathode A - Anode
PINS 1 & 2 - No Connection

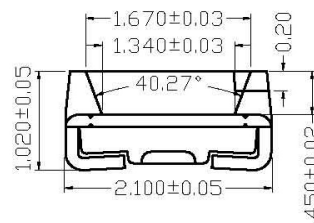

Forward V-I Characteristics

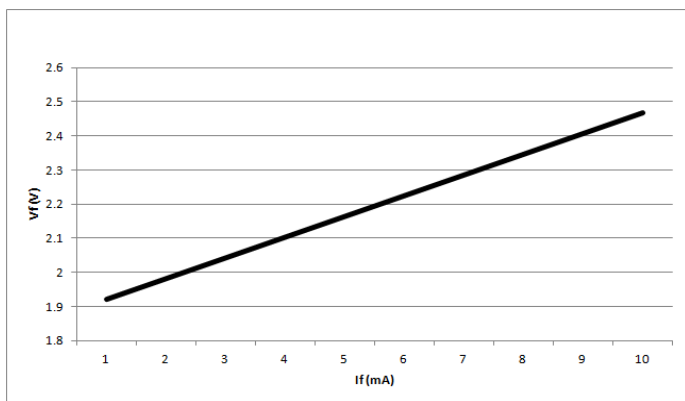

Unit: mm, Tolerance: ±0.2

Spectral Output

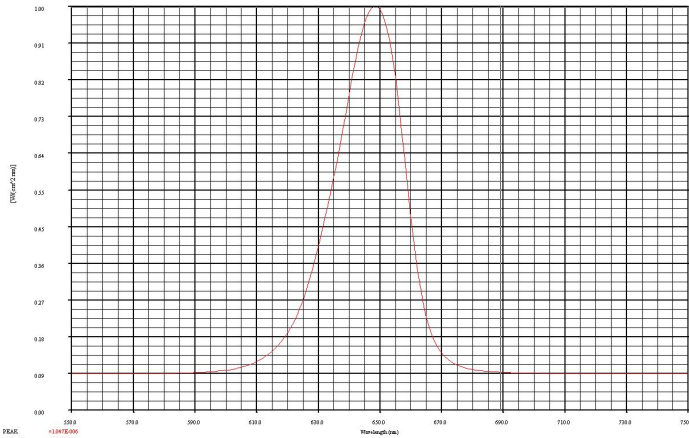

Radiation Pattern

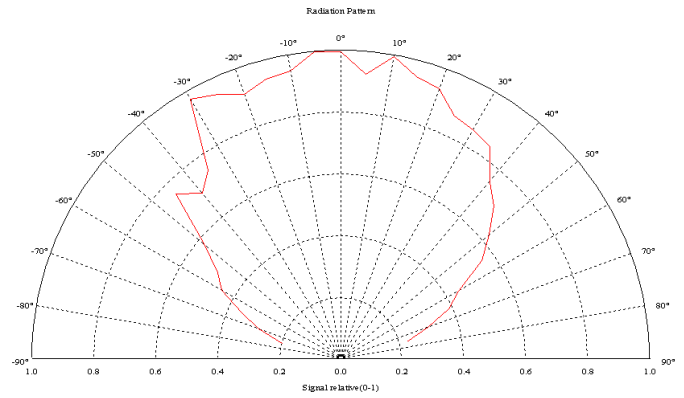

Red & Green Dot Solder Profile

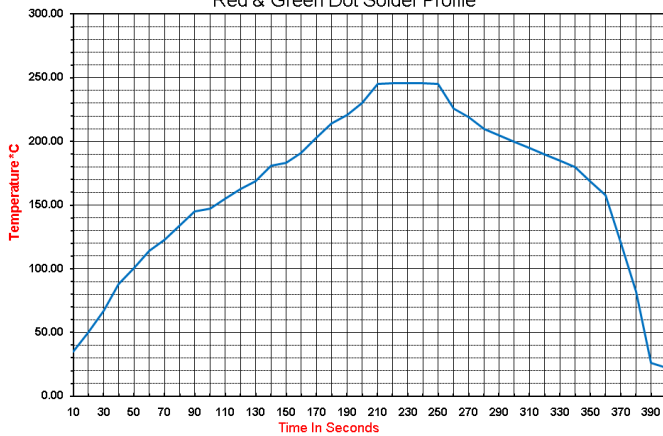

The information contained herein is subject to change without notice.

2023-10-17

Caution : This bag Contains **MOISTURE SENSITIVE DEVICES LEVEL 5A**

- 1 Calculated shelf life in sealed bag: **12 months at < 40 °C and < 90% humidity**
- 2 Peak Package Temperature: **80°C**
- 3 After bag is opened, devices that will be subjected to reflow solder or other high temperature processes must be (a) mounted within 24 hours of factory conditions **≤30°C/60% (b) Stored at <10% RH**
- 4 Devices require bake before mounting if humidity indicator card is >10% and/or conditions 3a or 3b are not met.
- 5 Recommended baking: **70°C** for 24 hours
- 6 Caution when handling the component. Do not touch the surface or expose to dust, particulates or other forms of contamination. Surface is easily scratched, marred or damaged which can affect the appearance and optical performance.
- 7 If cleaning is required, do not use harsh or unspecified chemicals. DI water or isopropyl alcohol is recommended. Please allow to dry at room temperature for 15 minutes before use. Extreme care when cleaning is required so as not to damage the LED surface.

Caution : Handling this product

- 1 Caution when handling the component. Do not touch the surface or expose to dust, particulates or other forms of contamination. Surface is easily scratched, marred or damaged which can affect the appearance and optical performance.
- 2 If cleaning is required, do not use harsh or unspecified chemicals. DI water or isopropyl alcohol is recommended. Please allow to dry at room temperature for 15 minutes before use. Extreme care when cleaning is required so as not to damage the LED surface.

NOTICE

The inherent design of this component causes it to be sensitive to electrostatic discharge(ESD). To prevent ESD-induced damage and/or degradation to equipment, take normal ESD precautions when handling this product