

Deep UV LED - 255nm

TO-Can 9Ø series (TUDx9F1B)

TUD59F1B



Product Brief

Description

- TUD59F1B is a deep ultraviolet light emitting diode with peak emission wavelengths from 250nm to 260nm. The LED is hermetically sealed inside a metal-glass welded package.
- It incorporates state of the art semiconductor material, chip design, and robust packaging with advanced optical characteristics.
- TUD59F1B is designed for optical sensing, medical and analytical instrumentation, and for chemical and biological analysis.

Features and Benefits

- UVC LED
- Robust metal-glass package
- Wide angular diagram
- Lead-free product
- RoHS compliant

Key Applications

- Sensors
- Fluorescent spectroscopy
- Chemical and biological Analysis

Table of Contents

Index

- Product Brief
- Table of Contents
- Performance Characteristics
- Characteristic Graphs
- Mechanical Dimensions
- Soldering Information
- Precaution for Use
- Company Information

Performance Characteristics

Table 1. Electro - Optical characteristic at 20mA

 (T_a=25°C, RH=30%)

Parameter	Symbol	Value			Unit
		Min.	Typ.	Max.	
Peak Wavelength ^[1]	λ_p	250		260	nm
Optical Output Power ^[2]	Φ_e ^[3]	0.2	0.4		mW
Forward Voltage ^[4]	V _F		6.0	7.5	V
Spectrum Half Width	$\Delta \lambda$		11	15	nm
View Angle	2 $\Theta_{1/2}$		120		deg.
Thermal Resistance (J to S) ^[5]	R θ_{J-S}		50		°C/W

Table 2. Absolute Maximum Rating

Parameter	Symbol	Value			Unit
		Min.	Typ.	Max.	
Forward Current	I _F	-	-	30	mA
Power Dissipation	P _D	-	-	180	mW
Operating Temperature ^[7]	T _{opr}	- 30	-	55	°C
Storage Temperature ^[7]	T _{stg}	- 30	-	100	°C

Notes :

1. Peak wavelength measurement tolerance: ± 3 nm
2. Optical Output Power measurement tolerance: ± 10%
3. Φ_e is the Optical Output Power as measured with an integrated sphere
4. Forward voltage measurement tolerance: ± 3%
5. R θ_{J-S} is the thermal resistance between chip junction and case
6. Exposure to the absolute maximum rated conditions may affect device reliability
7. At extreme temperatures - extra care must be taken to keep devices free from moisture

Characteristic Graphs

Fig 1. Spectrum, $T_a=25^\circ\text{C}$, $I_f=20\text{mA}$

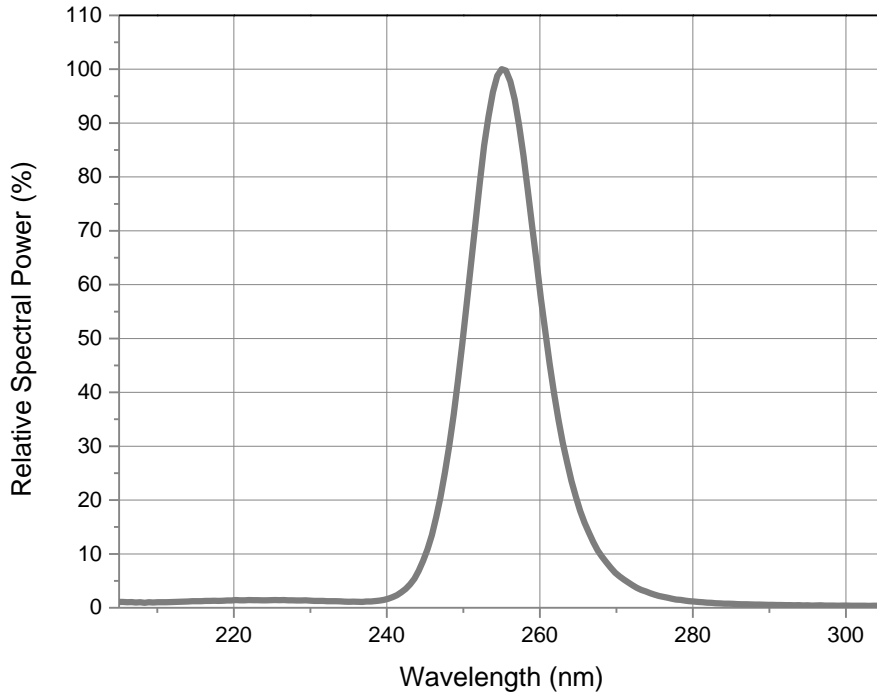
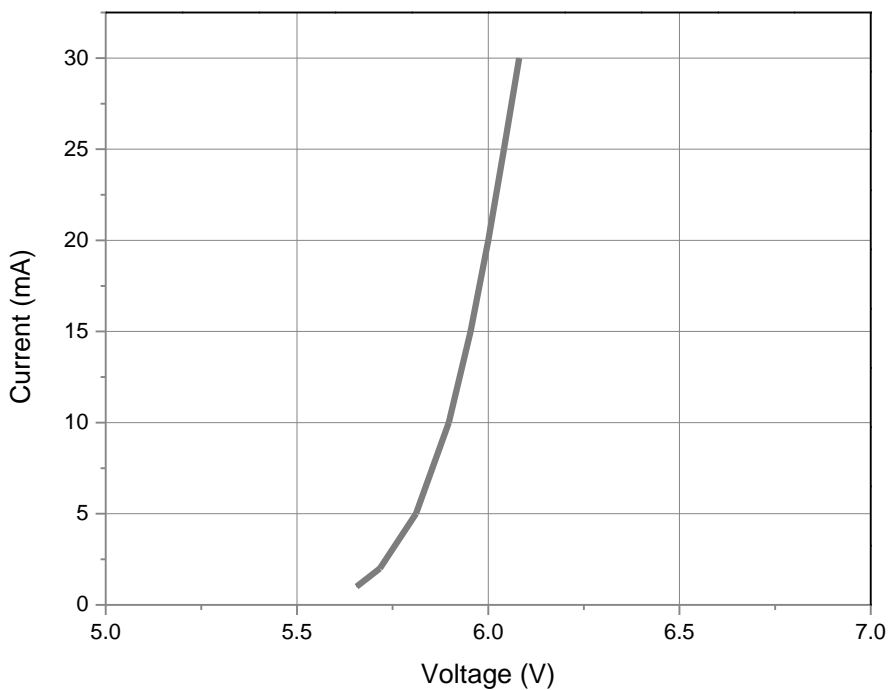

Fig 2. Forward Current vs. Forward Voltage, $T_a=25^\circ\text{C}$



Characteristic Graphs

Fig 3. Relative Optical Output Power vs. Forward Current, $T_a=25^\circ\text{C}$

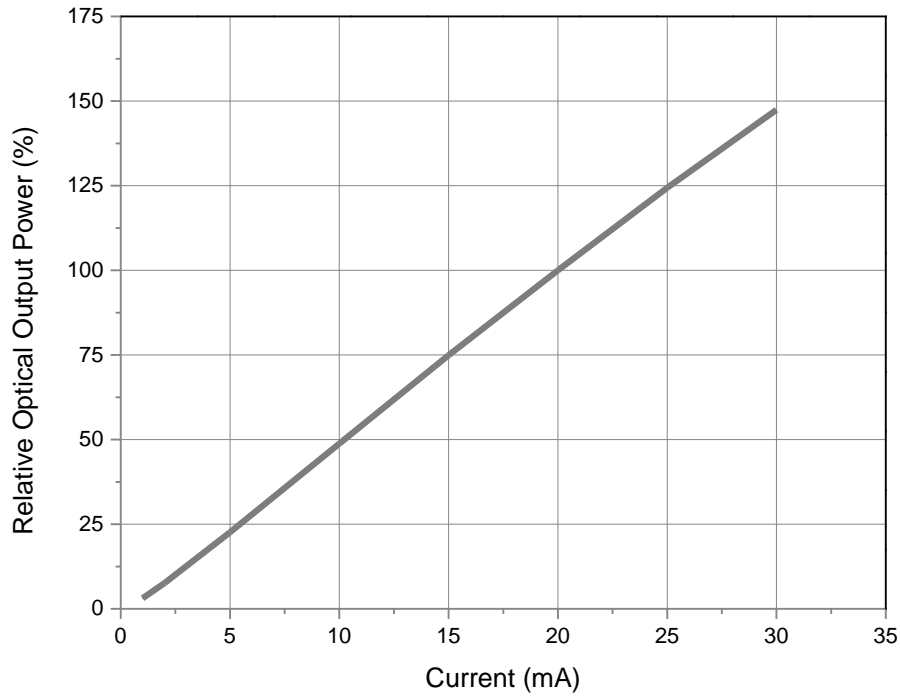
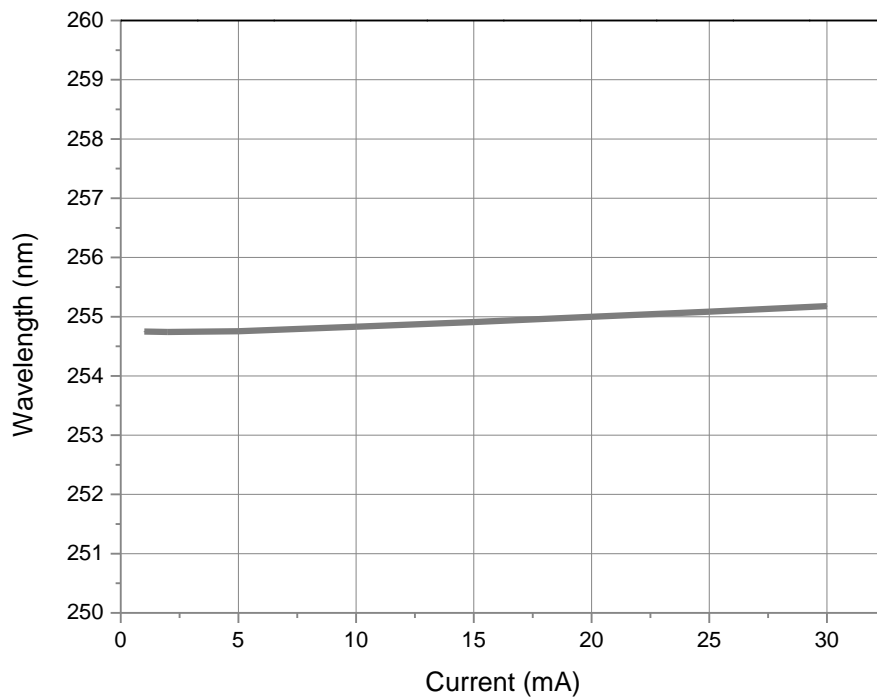

Fig 4. Peak Wavelength vs. Forward Current, $T_a=25^\circ\text{C}$



Characteristic Graphs

Fig 5. Relative Optical Output Power vs. Case Temperature, $I_F=20\text{mA}$

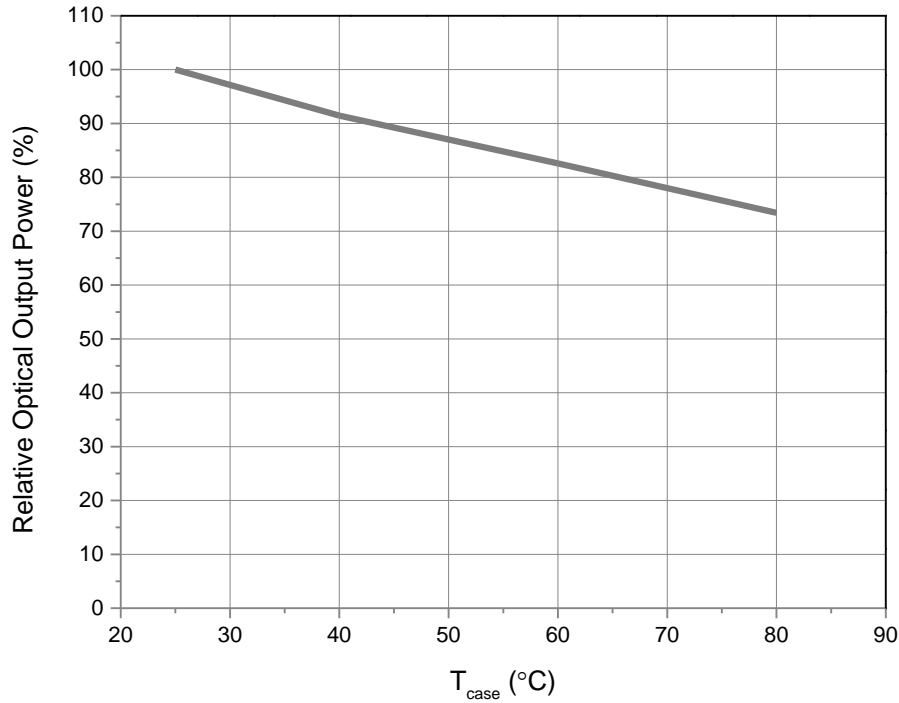
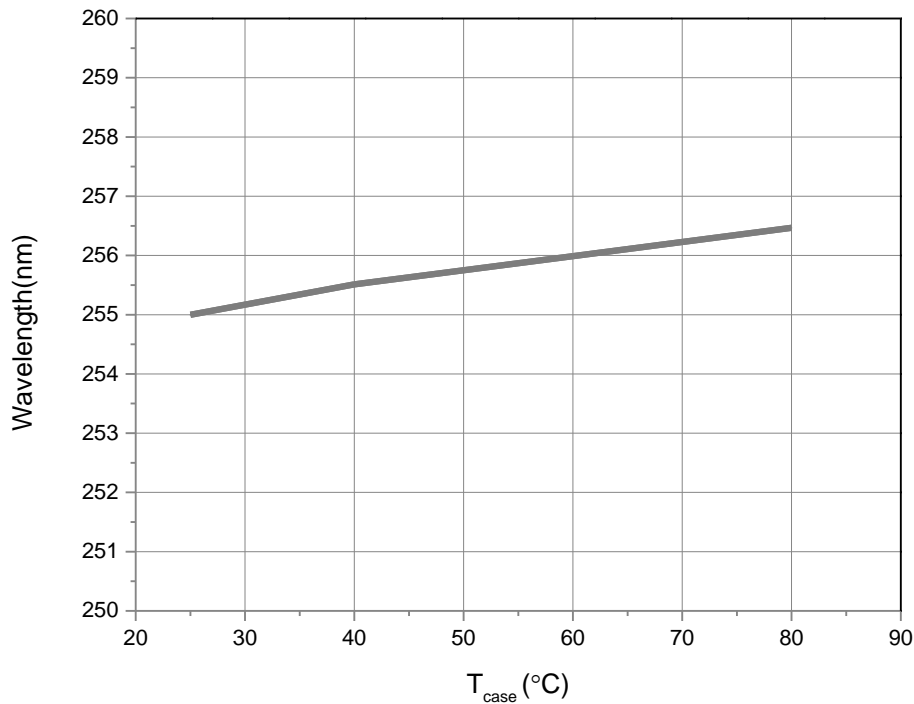

Fig 6. Peak Wavelength vs. Case Temperature, $I_F=20\text{mA}$



Characteristic Graphs

Fig 7. Forward Voltage vs Case Temperature, $I_F=20\text{mA}$

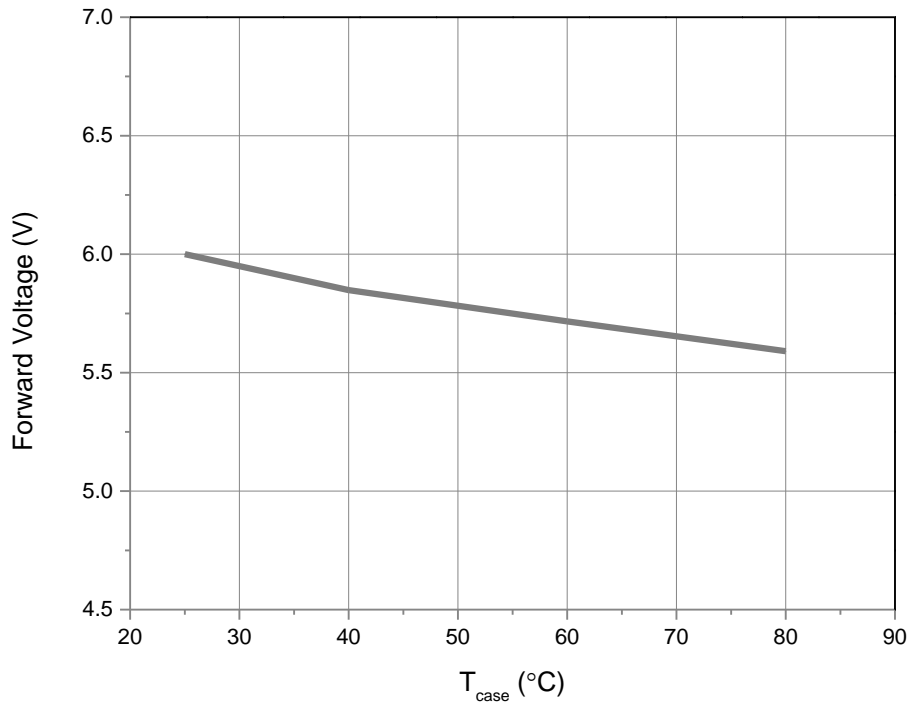
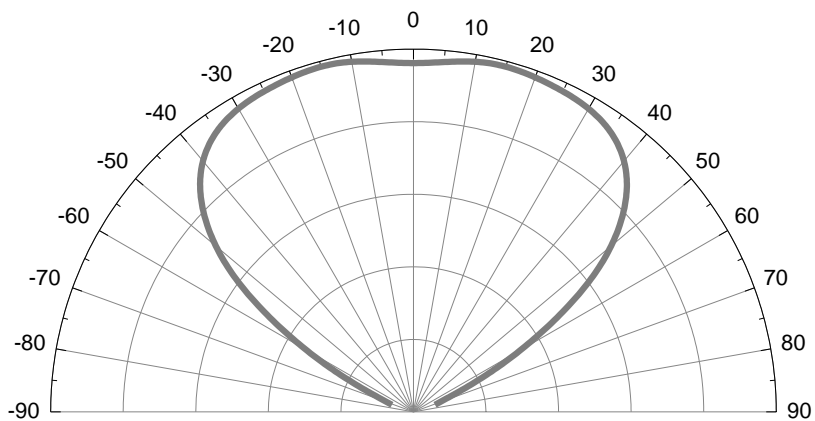
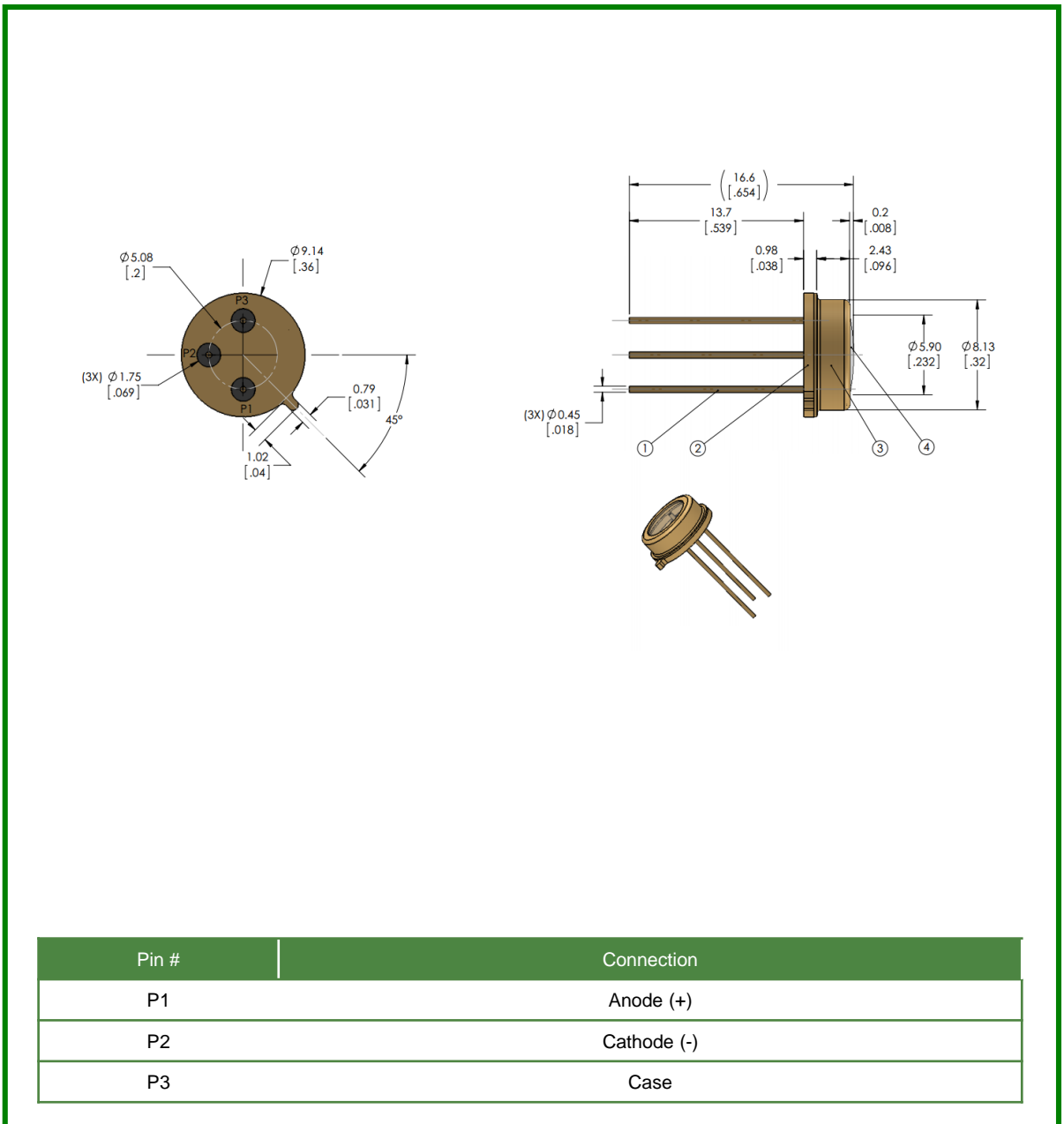

Fig 8. Typical Spatial Distribution, $I_F=20\text{mA}$



Mechanical Dimensions



Notes :

- [1] All dimensions are in millimeters
- [2] Not to scale
- [3] All dimensions for reference only

Soldering Information

A. Soldering Conditions

- **The following conditions must be avoided during soldering: overheating, ESD, mechanical shock, vibration, ultrasonic shock, mechanical damage and contamination.**
- Solder no closer than 3mm from the base of the header.
- Only solder to the package leads. Soldering to the LED header or the cap will result in damage to the device.
- If clamping the LED is required, mechanical stress on the LED should be minimized.
- Do not mount the LED directly on the PCB or heat sink by soldering directly to the LED header or cap.
- Only use non-corrosive flux.
- Only cut device leads at room temperature using an ESD protected tool. Do not apply stress to the leads while hot.
- Do not apply current to the device until it has cooled down to room temperature after soldering.
- When forming leads, the leads should be bent at a point at least 3mm from the base of the header.
- Form leads prior to soldering.
- Do not use header or can of LED to form leads.

B. Soldering Conditions

Dip Soldering		Hand Soldering	
Pre-Heat Time	30 seconds, max	Temperature at Case	190°C
Solder Bath Temperature	190°C	Soldering Time	5 seconds, max
Dipping Time	V _F	6.0	V

Precaution for Use

A. UV Light

- These devices are ultraviolet LEDs. During operation, the LED emits high intensity ultraviolet (UV) light, which is harmful to skin and eyes. Do not look directly into the UV light and wear protective equipment during operation.
- UV light is hazardous to skin and may cause cancer. Avoid exposure to UV light when LED is operational.
- Precautions must be taken to avoid looking directly at the UV light without the use of UV light protective glasses. Do not look directly at the front of the LED or at the LED's lens when LED is operational.
- **Attach the following warning labels on products/systems that use UV LEDs.**



B. Static Electricity

- Electrostatic discharge (ESD) is defined as the release of static electricity when two objects come into contact. While most ESD events are considered harmless, it can be an expensive problem in many industrial environments during production and storage. The damage from ESD to an LEDs may cause the product to demonstrate unusual characteristics such as:
 - Increase in reverse leakage current lowered turn-on voltage
 - Abnormal emissions from the LED at low current
- The following recommendations are suggested to help minimize the potential for an ESD event.
- One or more recommended work area suggestions:
 - Ionizing fan setup
 - ESD table/shelf mat made of conductive materials
 - ESD safe storage containers
- One or more personnel suggestion options:
 - Antistatic wrist-strap
 - Antistatic material shoes
 - Antistatic clothes
- Environmental controls:
 - Humidity control (ESD gets worse in a dry environment)

Precaution for Use

C. Operating Conditions

- In order to ensure the correct functioning of these LEDs, compliance to the maximum electrical specifications is paramount. These LEDs are particularly sensitive to any current value that exceeds the absolute maximum rating of the product. Any applied current in excess of the maximum specification will cause damage and possible complete failure of the product.
- The current flowing in a LED is an exponential function of the voltage across it. A small change in voltage can produce a very large change in current and lead to complete failure of the LED. The use of current regulated drive circuits are recommended for these products.
- **Any attempt to drive these UV LEDs with a voltage source instead of a current source will cause damage and possible complete failure of the product.**
- These devices are not designed to be used under negative bias.
- This device is not to be used in any type of fluid such as water, oil, organic solvent, etc.
- These LEDs are susceptible to heat generation. Use care to design end product with adequate thermal management to ensure that LEDs do not exceed maximum recommended temperatures. Operating LEDs at temperatures in excess of specification will result in damage and possible complete failure of the product. When the LEDs are in operation the maximum current should be decided after measuring the package temperature.
- The driving circuit must be designed to allow forward voltage only when it is ON or OFF. If the reverse voltage is applied to LED, migration can be generated resulting in LED damage.
- EOS (Electrical Over Stress) – EOS is defined as damage that may occur when an electronic device is subjected to a current or voltage that is beyond the maximum specification limits of the device. The effects from an EOS event can be noticed through product performance like:
 - Changes to the performance of the LED package (If the damage is around the bond pad area and since the package is completely encapsulated the package may turn on but flicker or show severe performance degradation.)
 - Changes to the light output of the luminaire from component failure
 - Components on the board not operating at determined drive power
 - Failure of performance from an entire fixture due to changes in circuit voltage and current across total circuit causing trickle down failures.
- It is impossible to predict the failure mode of every LED exposed to electrical overstress as the failure modes vary significantly, but there are some common signs that will indicate an EOS event has occurred:
 - Damaged may be noticed to the bond wires (appearing similar to a blown fuse)
 - Damage to the bond pads located on the emission surface of the LED package (shadowing can be noticed around the bond pads while viewing through a microscope)
 - Anomalies noticed in the encapsulation and phosphor around the bond wires. This damage usually appears due to the thermal stress produced during the EOS event.

Precaution for Use

C. Operating Conditions - Continued

- To help minimize the damage from an EOS event Seoul Viosys recommends utilizing:
 - A surge protection circuit
 - An appropriately rated over voltage protection device
 - A current limiting device

D. Storage

- To avoid moisture penetration, we recommend storing UV LEDs in a dry box with a desiccant. The recommended temperature and relative humidity are between 5°C and 30°C and below 50% respectively.
- LEDs must be stored properly to maintain the device. If the LEDs are stored for 3 months or more after being shipped from SETI, a sealed container with a nitrogen atmosphere should be used for storage.
- Replace the remained LEDs into the moisture-proof bag and reseal the bag after work to avoid those LEDs being exposed to moisture. Prolonged exposure to moisture can adversely affect the performance of the LEDs.
- If the package has been open for more than 168hr or the color of the desiccant changes, components should be dried for 10-12hr at 60±5°C.
- The conditions of resealing should be as follows: Temperature between 5 and 40°C and relative humidity less than 30%

E. Handling Precautions

- VOCs (Volatile organic compounds) emitted from materials used in the construction of fixtures can penetrate the LED packages and affect LED performance and lifetime. Knowledge of the properties of the materials selected to be used in the construction of fixtures can help prevent these issues.
- When attaching LEDs, do not use adhesives that outgas organic vapor.
- Soldering should be done as soon as possible after opening the moisture-proof bag.
- Do not rapidly cool device after soldering.
- Do not apply mechanical force or excess vibration during the cooling process to normal temperature after soldering.
- Components should not be mounted on warped (non coplanar) portions of a PCB.
- The UV LED is protected by a lens which requires careful handling
 - Avoid touching glass lens parts especially with sharp tools such as tweezers
 - Avoid leaving fingerprints on glass lens parts.
- Do not handle this product with acid or sulfur material in sealed space.

F. Cleaning

- If cleaning is required, isopropyl alcohol or water with immediate drying is recommended. Do not use ultrasonic cleaning.

Company Information

Published by

Seoul Viosys © 2013 All Rights Reserved.

Company Information

Seoul Viosys (www.seoulviosys.com) manufactures light emitting diodes (LEDs) with a full range of UV wavelengths from UVC to UVA (under 400nm) for Industrial Curing, Air/Water Purification, Disinfection and Home appliance.

The company is one of the world leading UV LED supplier, holding more than 4,000 patents globally, while offering various kinds of LED technologies and application-solutions in High power UV LED, UV sensor, UV LED Lamp and variety of UV LED sourced Applications.

The company's broad product portfolio includes hybrid modules for unique applications such as UV disinfection, deodorization, UV purification as well as customized modules for your Application.

Legal Disclaimer

Information in this document is provided in connection with Seoul Viosys products. With respect to any examples or hints given herein, any typical values stated herein and/or any information regarding the application of the device, Seoul Viosys hereby disclaims any and all warranties and liabilities of any kind, including without limitation, warranties of non-infringement of intellectual property rights of any third party. The appearance and specifications of the product can be changed to improve the quality and/or performance without notice.