

Cree LED UltraThin[®] UT190[™] Gen 3 LEDs

CxxxUT190-Sxxxx-31

Data Sheet (50 μm chip thickness)

Cree LED's UT190 LEDs combine highly efficient InGaN materials with Cree LED's proprietary G•SiC[®] substrate to deliver superior price/performance for blue LEDs. These vertically structured LED chips are small and thin with low forward voltage. Cree LED's UT[™] series chips are 100% tested for conformity to optical and electrical specifications, as well as the ability to withstand a 2000 V ESD pulse. Applications include consumer products, mobile devices and automotive applications where a small, thin form factor is required.

FEATURES

- Wavelengths for Blue, Green and White-conversion
- 50 μm Chip Thickness
- RF Performance:
 - 450 nm – 12+ mW
 - 460 nm – 10+ mW
 - 470 nm – 10+ mW
 - 527 nm – 4+ mW
- Low Forward Voltage
 - 2.9 V Typical at 5 mA
- Conductive Adhesive Die Attach
- Single Wire Bond, Vertically Conductive Structure
- 2kV Class 2 ESD Rating

APPLICATIONS

- Indicator Applications
 - Consumer Products
 - Mobile Devices
 - Product Displays
 - White Goods
- Automotive Applications
 - Interior Indicators
 - Meter Cluster Lighting
 - Center Stack Displays

CxxxUT190-Sxxxx-31 Chip Diagram

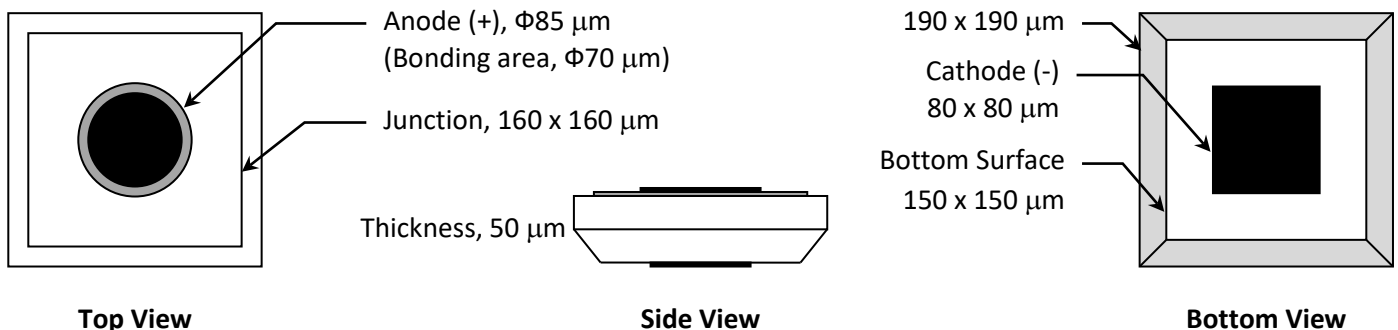



Maximum Ratings at $T_A = 25^\circ\text{C}$ <small>Notes 1&3</small>		CxxxUT190-Sxxxx-31
DC Forward Current		30 mA
Peak Forward Current (1/10 duty cycle @ 1 kHz)		100 mA
LED Junction Temperature		125°C
Reverse Voltage		5 V
Operating Temperature Range		-40°C to +100°C
LED Chip Storage Temperature Range (LED Chip only, not for Die Sheet Storage)		-40°C to +120°C
Recommended Die Sheet Storage Conditions		$\leq 30^\circ\text{C}$ / $\leq 85\%$ RH
Electrostatic Discharge Threshold (HBM) <small>Note 2</small>		2000 V
Electrostatic Discharge Classification (MIL-STD-883E) <small>Note 2</small>		Class 2

Typical Electrical/Optical Characteristics at $T_A = 25^\circ\text{C}$, $I_f = 5\text{ mA}$ <small>Note 3</small>					
Part Number	Forward Voltage (V_f , V)			Reverse Current [$I(V_r=5\text{ V})$, μA]	Full Width Half Max (λ_D , nm)
	Min.	Typ.	Max.	Max.	Typ.
C450UT190-Sxxxx-31	2.7	2.9	3.1	2	21
C460UT190-Sxxxx-31	2.7	2.9	3.1	2	21
C470UT190-Sxxxx-31	2.7	2.9	3.1	2	22
C527UT190-Sxxxx-31	2.7	3.0	3.2	2	35

Mechanical Specifications		CxxxUT190-Sxxxx-31	
Description	Dimension	Tolerance	
P-N Junction Area (μm)	160 x 160	± 25	
Chip Top Area (μm)	190 x 190	± 25	
Chip Bottom Area (μm)	150 x 150	± 25	
Chip Thickness (μm)	50	± 10	
Au Bond Pad Diameter (μm)	85	-5, +15	
Bonding Area <small>Note 5</small> Diameter (μm)	70	-5, +15	
Au Bond Pad Thickness (μm)	1.2	± 0.5	
Backside Contact Metal Area (μm)	80 x 80	± 25	

Notes:

- Maximum ratings are package dependent. The above ratings were determined using a thru-hole package (with Hysol® OS4000 encapsulant) for characterization. Ratings for other packages may differ. The forward currents (DC and Peak) are not limited by the die but by the effect of the LED junction temperature on the package. The junction temperature limit of 125°C is a limit of the thru-hole package; junction temperature should be characterized in a specific package to determine limitations. Assembly processing temperature must not exceed 325°C (< 5 seconds).
- Product resistance to electrostatic discharge (ESD) according to the HBM is measured by simulating ESD using a rapid avalanche energy test (RAET). The RAET procedures are designed to approximate the minimum ESD ratings shown. The ESD classification of Class 2 is based on sample testing according to MIL-STD-883E.
- All products conform to the listed minimum and maximum specifications for electrical and optical characteristics when assembled and operated at 5 mA within the maximum ratings shown above. Efficiency decreases at higher currents. Typical values given are within the range of average values expected by manufacturer in large quantities and are provided for information only. All measurements were made using lamps in thru-hole packages (with Hysol OS4000 encapsulant). Optical characteristics measured in an integrating sphere using Illuminance E.
- Caution: To obtain optimum output efficiency, the amount of epoxy used should be characterized based upon the specific application.
- Bonding Area is defined as the bond pad area exposed through the opening in the passivation layer. Care should be taken to prevent the wire bond from overlapping the passivation layer to maintain optimal bond performance and minimize the risk of mechanical damage.

Standard Bins for CxxxUT190-Sxxxx-31

LED chips are sorted to the **radiant flux** and **dominant wavelength** bins shown. Sorted die sheets contain die from only one bin. Sorted die kit (CxxxUT190-Sxxxx-31) orders may be filled with any or all bins (CxxxUT190-xxxx-31) contained in the kit. All radiant flux values are measured at $I_f = 20 \text{ mA}$ and all dominant wavelength values are measured at $I_f = 5 \text{ mA}$.

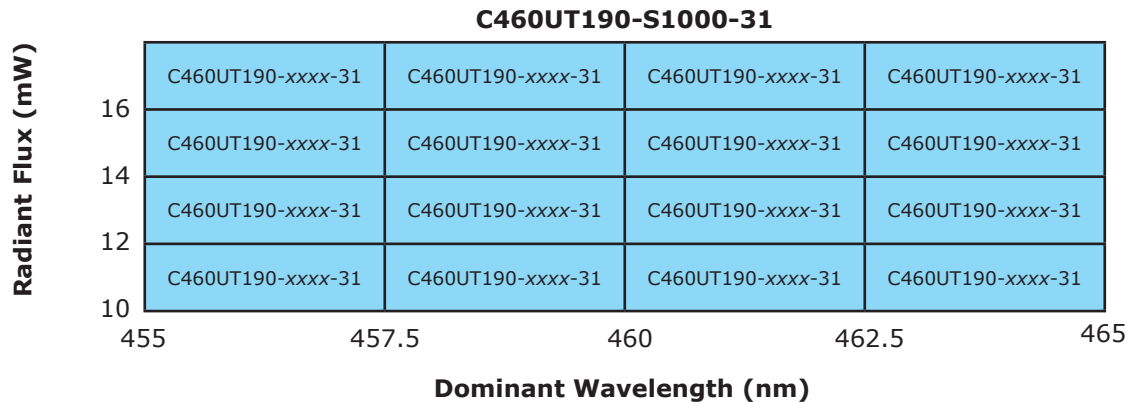
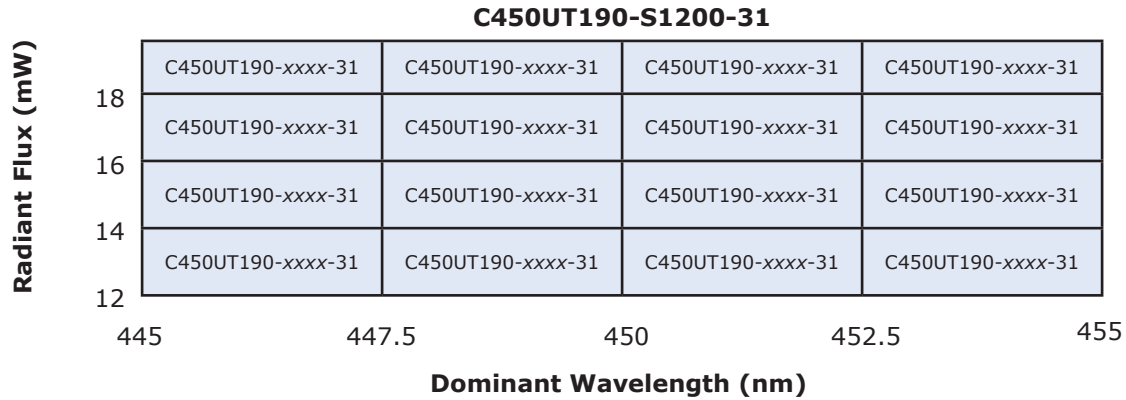

Standard Bins for CxxxUT190-Sxxxx-31 (continued)

LED chips are sorted to the **radiant flux** and **dominant wavelength** bins shown. Sorted die sheets contain die from only one bin. Sorted die kit (CxxxUT190-Sxxxx-31) orders may be filled with any or all bins (CxxxUT190-xxxx-31) contained in the kit. All radiant flux values are measured at $I_f = 20 \text{ mA}$ and all dominant wavelength values are measured at $I_f = 5 \text{ mA}$.

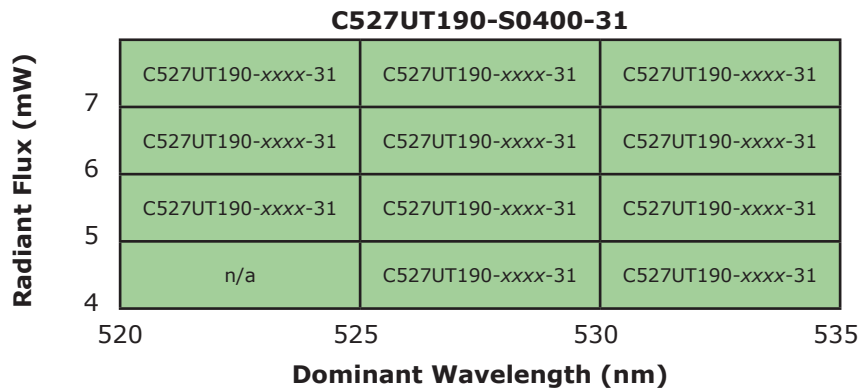
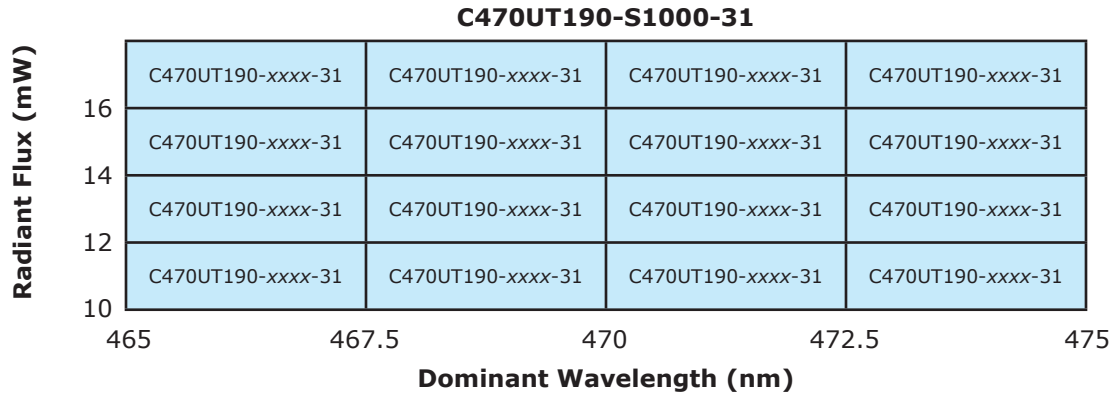

Characteristic Curves

These are representative measurements for the UT product. Actual curves will vary slightly for the various radiant flux and dominant wavelength bins.

Forward Current vs. Forward Voltage

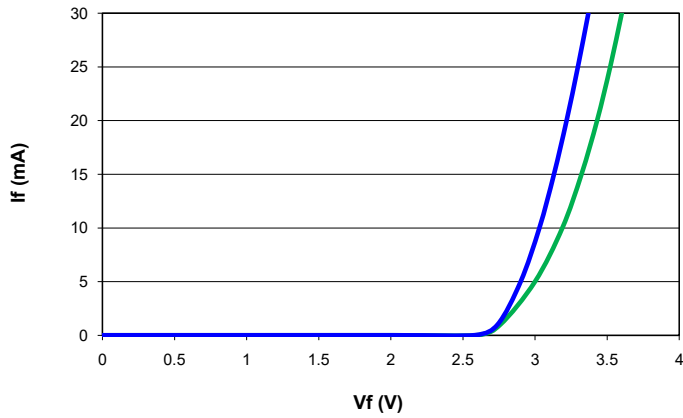

Wavelength Shift vs. Forward Current

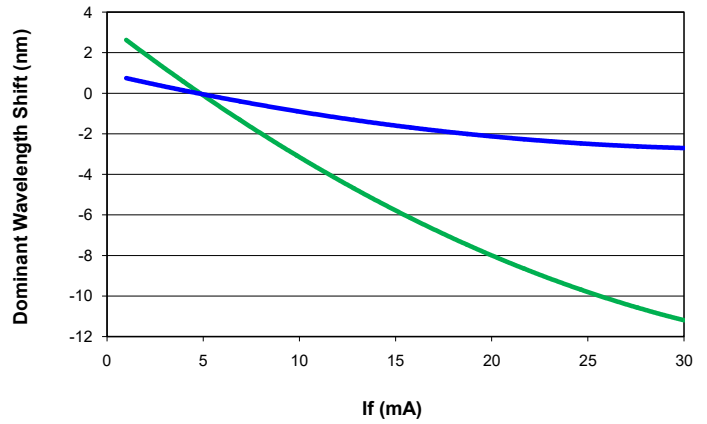

Relative Intensity vs. Forward Current

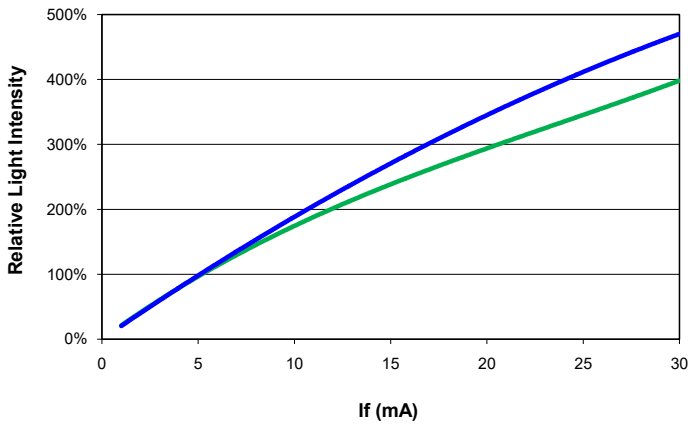

Radiation Pattern

This is a representative radiation pattern for the UT Chip LED product. Actual patterns will vary slightly for each chip.

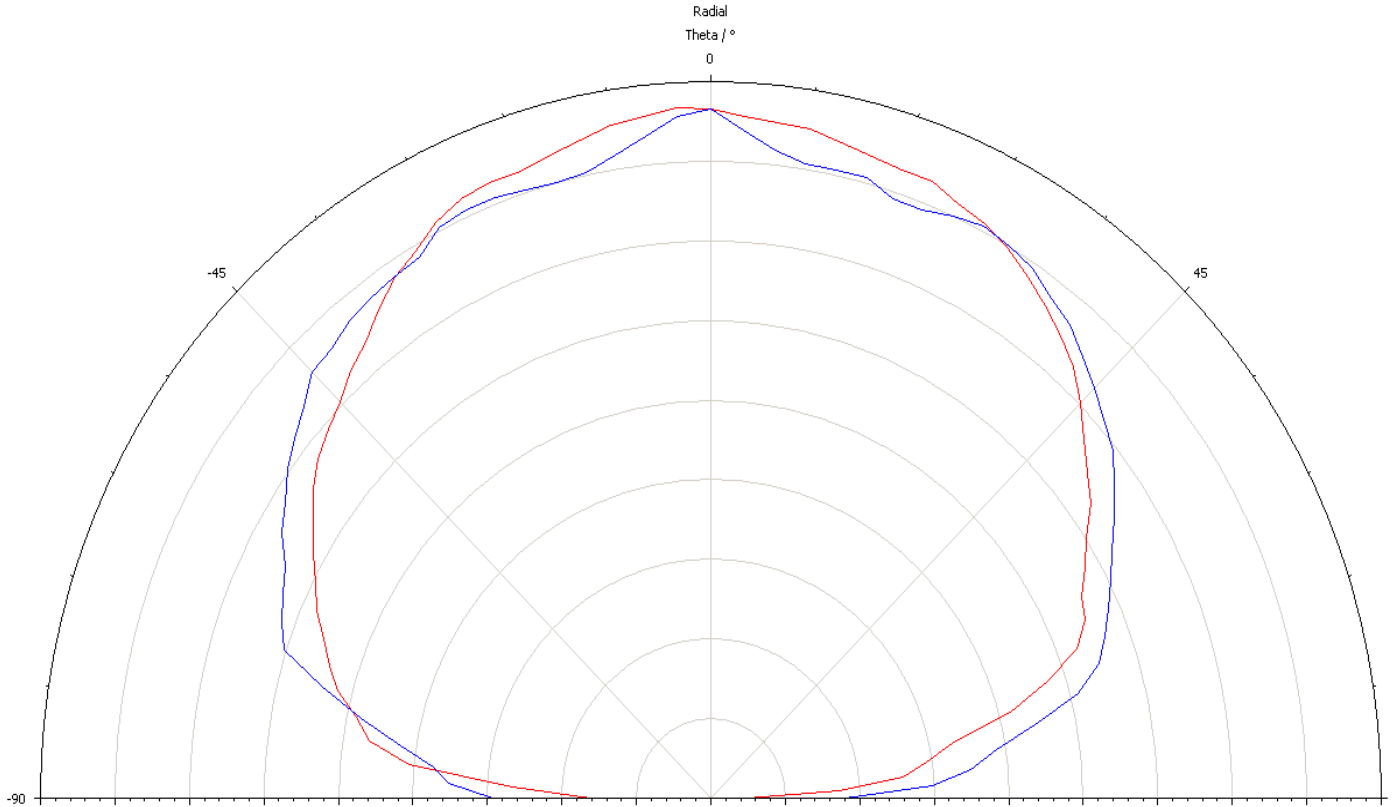

Product Content Information and Warnings

This information is not intended as legal advice. Consult a qualified lawyer if you are unfamiliar with the applicability of China RoHS 2 and/or California Proposition 65 to your business and products.

China RoHS 2

	<p>This green “e” logo is included on this product datasheet to indicate that the Cree LED product described herein does not include any of chemicals regulated under China RoHS 2 above permissible threshold limits. As applicable, each customer that incorporates this Cree LED product into its higher-level product needs to decide on the appropriate China RoHS 2 label for its higher-level product based on any other regulated content used in its product. If no other regulated content is present, this green “e” logo also may be used for the customer’s product.</p>
---	---

Pursuant to Management Methods for Restricted Use of Hazardous Substances in Electrical and Electronic Products, an administrative order published by the Chinese Ministry of Industry and Information Technology (MIIT) and effective as of July 1, 2016 (more commonly known as “China RoHS 2”), electronic and electrical end products (EEPs) sold into China must be marked with a logo to indicate whether or not they contain any of the chemicals regulated under China RoHS 2 (i.e., lead, mercury, cadmium, hexavalent chromium, polybrominated biphenyls, or polybrominated diphenyl ethers) above the permissible threshold limits. As of March 2018, the list of EEPs includes refrigerators, air conditioners, washing machines, water heaters, printers, copiers, fax machines, TV sets, monitors, microcomputers, cell phones, and telephones. This list is subject to modification by the MIIT.

According to MIIT guidance, suppliers supporting the manufacture of EEPs (i.e., component suppliers) may—but are not required to—include a label on their component products. However, if a component product includes one of the regulated substances, the component supplier must provide the purchaser with information in a prescribed tabular format to facilitate labeling EEPs. The table must disclose the type and location of the hazardous substances contained in the component product. If a component product that could be used in an EEP is sold separately in the market, the component product falls within the scope of China RoHS unless the final purpose is known to be out of scope. A supplier that does not directly sell products in China should nevertheless comply with China RoHS 2 if there is a possibility that its products or products incorporating its products will be sold in China. For more information about China RoHS, please refer to <http://www.chinarohs.com/docs.html>.

California Proposition 65 Warnings

This Cree LED semiconductor die product (excluding packaging) does not contain any chemicals that must be disclosed under California Proposition 65 (officially titled the Safe Drinking Water and Toxic Enforcement Act of 1986, codified at Cal. Health & Saf. Code §§ 25249.5–.13) enacted by the State of California. This die product, however, is packaged using PVC die transfer film that contains Diisononyl Phthalate (DINP), a chemical known to the State of California to cause cancer and/or birth defects or other reproductive harm. If you are located in the State of California, the presence of DINP in the PVC die transfer film results in the need for you to provide an occupational warning under Proposition 65. Pursuant to California Health and Safety Code § 25606, you must post Proposition 65 compliant warnings at your place(s) of business in California to warn your employees and contractors who may come into contact with the PVC die transfer film during use and handling of the Cree LED die products, including in connection with the development or manufacture of higher-level products. Specifically, for indoor environments or outdoor spaces with clearly defined entrances, a warning sign must be posted at all public entrances to the affected area and, in no smaller than 72-point type, read substantially as follows:

	<p>WARNING: Entering this area may expose you to Diisononyl Phthalate (DINP), a chemical known to the State of California to cause cancer and birth defects or other reproductive harm. DINP is present in the PVC die transfer film on which certain semiconductor die products sold by CreeLED, Inc. or one of its affiliates are delivered. Please refer to the Cree LED website at www.cree-led.com/about/suppliers-contractors/prop-65 to verify which Cree LED semiconductor die products are delivered on this type of PVC die transfer film. For more information on California’s Proposition 65 warnings, go to www.P65Warnings.ca.gov.</p>
---	---

This occupational warning must be provided in English and in any other language used on other signage in the affected area. Since the Cree LED die products themselves do not contain DINP, their incorporation into your products will not create an obligation for you to include a Proposition 65 warning on your products. Please insure ensure that the PVC die transfer film is properly handled and properly disposed of as a hazardous material after die removal.

Please refer to the Cree LED website at www.cree-led.com/about/suppliers-contractors/prop-65 to verify which Cree LED semiconductor die products are delivered on this type of PVC die transfer film.